

Power Generation Development Plan-2012 Ashuganj

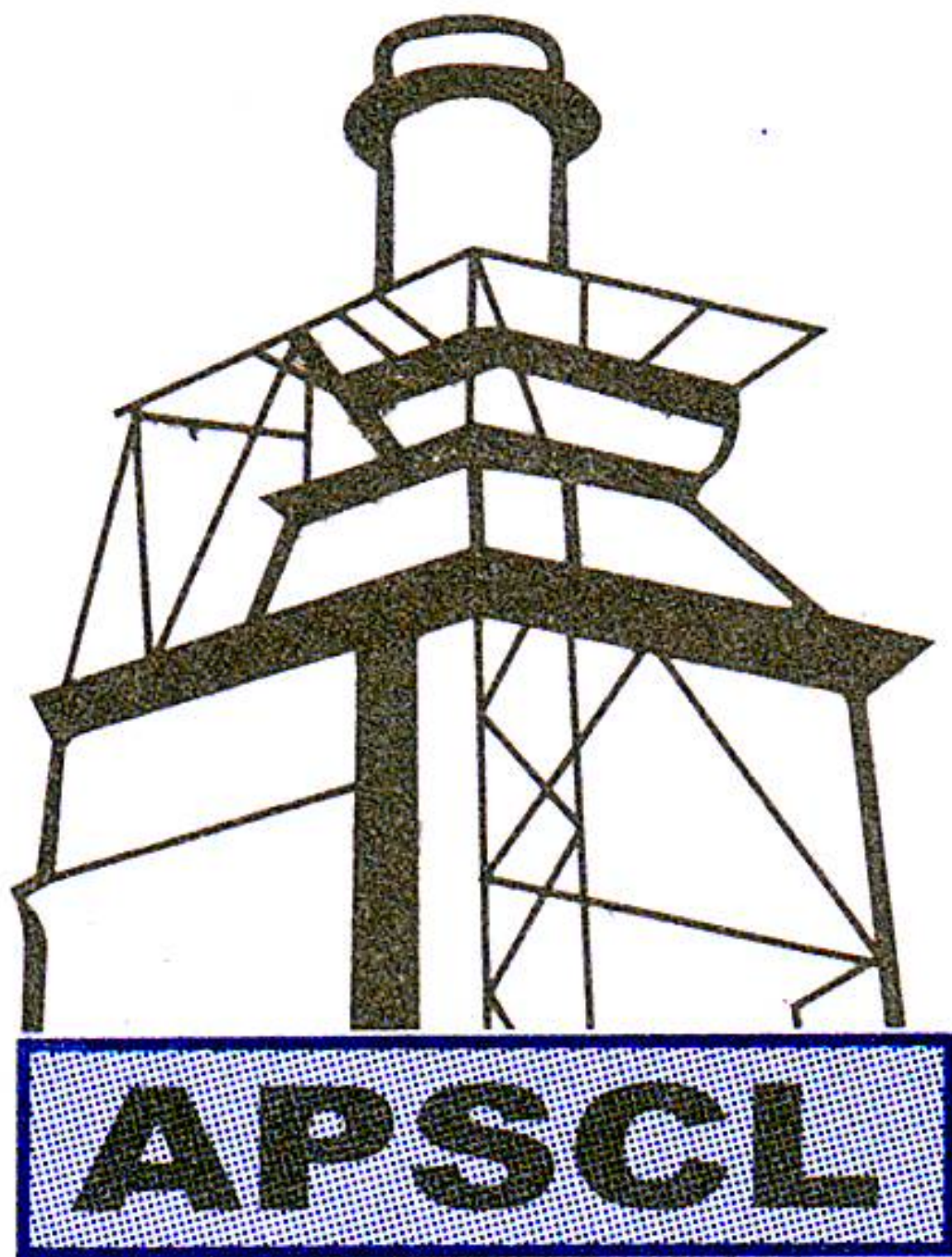

Ashuganj Power Station Company Ltd.

Our Vision

To become the leading power
generation company in
Bangladesh

Mission

To increase the Ashugonj Power
Station's Generation Capacity to
1700MW by 2015

Background of Ashuganj Thermal Power Plant:

The foundation of Ashuganj Thermal Power Plant was laid in 1966. For this purpose a land of 311 acre situated north-east of Meghna Railway Bridge was acquired. With the financial help of the then German Government the establishment of two units (Unit-1 & 2) having the generation capacity of 128MW was started. In 1968 the establishment of main equipments was started and in April/July of 1970 the two units were commissioned. After the liberation war Ashuganj Power Station has played an important role for the reconstruction & economical development of war-stricken Bangladesh.

After the independence the economical condition of Bangladesh started to change. Gradually the demand of electricity started to rise. To meet the extra demand of electricity an expansion plan of Ashuganj Thermal Power Plant was taken. After examining the possibility of expansion of Ashuganj Thermal Power Plant a plan was taken to establish 3 units having a generation capacity of 150MW each.

From 1986 to 1989 3 units (Ashuganj 3, 4 & 5) were established with the financial help of IDA, KfW (German Government), Kuwait & OPEC fund and ADB.

From 1982 to 1986 for the first time in the Bangladesh a Combine Cycle Power Plant having a generation capacity of 146MW was establish with the financial support of British Government.

In 1989 the established generation capacity of Ashuganj Thermal Power Plant was as below:

SL no.	Unit	Establish generation capacity (MW)
1.	Unit-1	64
2.	Unit-2	64
3.	Unit-3	150
4.	Unit-4	150
5.	Unit-5	150
6.	GT-1	56
7.	GT-2	56
8.	ST	34
	Total	724

From 1989 to 2010 no new plant was establish in Ashuganj. Till June 2000 the Ashuganj Thermal Power Plant was directed by Bangladesh Power Development Board. After the transformation to Company a new unit having a generation capacity of 53 MW was establish with the self fund of the company in 2011.

Reform of Ashuganj Thermal Power Station into Ashuganj Power Station Company Limited (APSCL):

As a part of the Power Sector Development and Reform Program of the Government of Bangladesh (GOB) Ashuganj Power Station Company Ltd. (APSCL) has been incorporated under the Companies Act 1994 on 28 June 2000. The Registration No. of APSCL is C-40630 (2328)/2000. Ashuganj Power Station (APS) Complex (with its Assets and Liabilities) had been transferred to the APSCL through a Provisional Vendor's Agreement signed between BPDB and APSCL on 22 May 2003. All the activities of the company started formally on 01 June 2003. From that day the overall activities of the company along with operation, maintenance and development of the Power Station are vested upon a Management Team consisting of the Managing Director, the Director (Technical) & the Director (Finance).

According to the Articles of Association of the Company, 51% of total shares is held by BPDB and the rest 49% is distributed among Ministry of Planning, Power Division, MOPEMR & Energy Division, MOPEMR of GOB.

APSCL Board of Directors:

1. Mr. Foiz Ahamed, Additional Secretary (Admin), Power Division, Ministry of Power, Energy & Mineral Res. & Chairman, APSCL.
2. Mr. Shafat Ahmed Choudhuri, Additional Secretary (Admin/Operation), Ministry of Power, Energy & Mineral Res. & Director, APSCL.
3. Mr. Md. Anwar Hossain, Joint Secretary (Development) , Power Division, Ministry of Power, Energy & Mineral Res. & Director, APSCL.
4. Mr. Md. Harunur Rashid, Joint Secretary, Prime Minister's Office & Director, APSCL.
5. Dr. Md. Quamrul Ahsan, Professor, Dept. of Electrical & Electronic Engg., BUET & Director, APSCL.
6. Mr. Tamal Chakraborty, Member(Generation), BPDB & Director, APSCL.
7. Mr. Md. Abul Quasem, Member (Company affairs), BPDB & Director, APSCL.
8. Mr. Mamtaz Uddin Ahmed, President, ICMAB & Director, APSCL.
9. Mr. Md. Abduhu Ruhullah, Member (P&D), BPDB & Director, APSCL.
10. Mr. Md. Shamsul Haque, Director, FBCCI & Director, APSCL
11. Mr. Md. Nurul Alam, Managing Director, APSCL.

Present Company Status:

Name	: Ashuganj Power Station Company Ltd. (APSCL)
Corporate Office	: Ashuganj, Brahmanbaria-3402
Registration No.	: C-40630 (2328)/2000
Registration Date	: 28 june 2000
Company Status	: Public Limited Company
Main Work	: Power Generation
Number of Generation Units	: 9 (6 Steam Turbine + 2 Gas Turbine + 1 Gas Engine)
Installed Capacity	: 777 MW
Present de-rated capacity	: 731 MW
Dependable Capacity	: 573 MW
Authorized Capital in Taka	: 30,000,000,000
Paid up Capital in Taka	: 10,00,000
Area of Land	: 263.55 Acres
Manpower	: 517 (Regular employee)
Company Website	: www.apscl.com
Email	: apscl@apscl.com , apsclbd@yahoo.com



Geographical Position of Ashuganj Power Station Company Ltd.

Ashuganj Power Station Company Ltd. is situated at the bank of river Meghna and 90k.m. north-east away of capital city Dhaka.

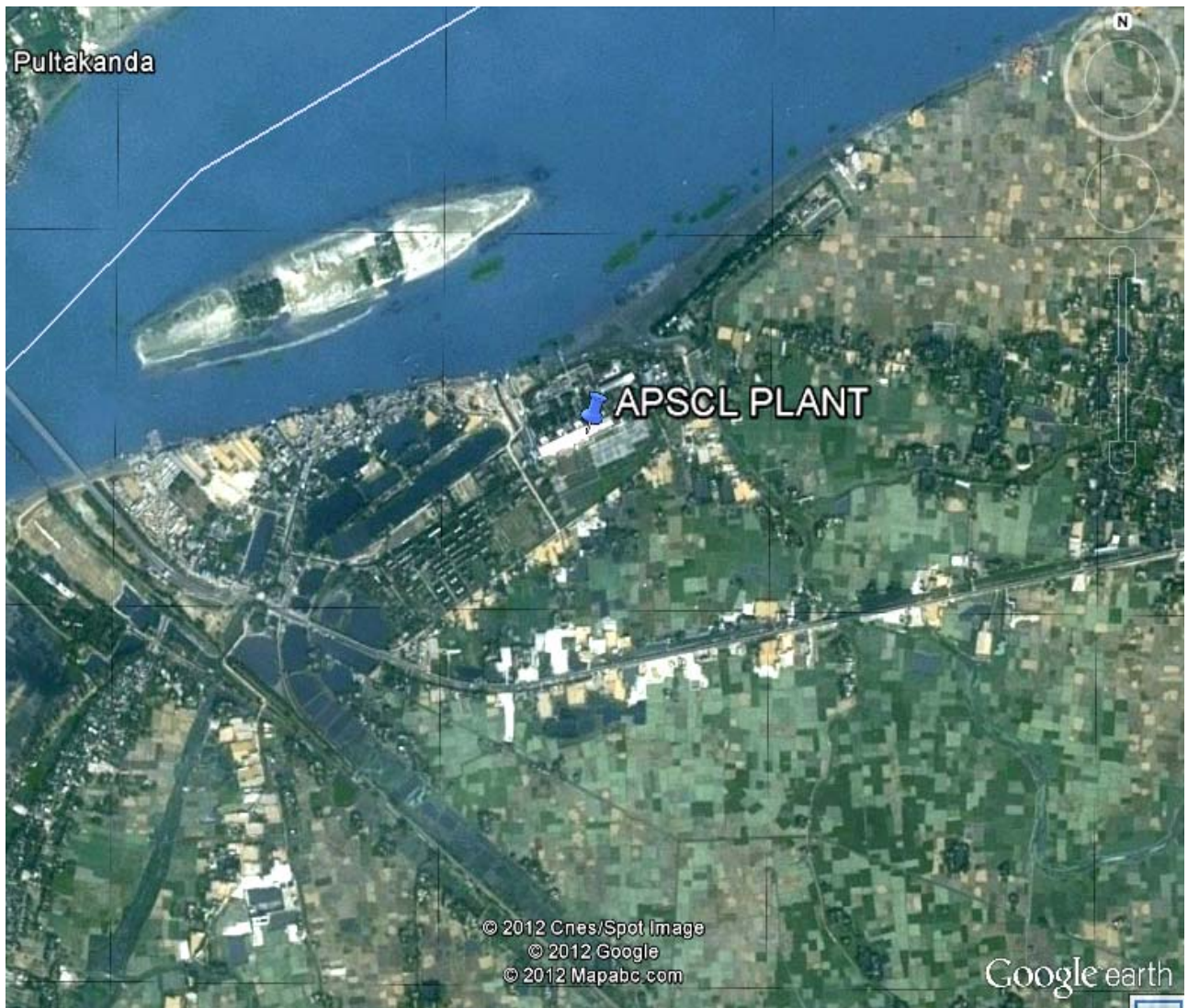

Geographical Position of APSCCL: Satellite Picture

Government & Self Governed Institution & Other Infrastructure nearest to Ashuganj Power Station Company Ltd.

1. Silo (Food storage)
2. Ashuganj Fertilize & Chemical Company Ltd.
3. Martyr Abdul Halim Bridge
4. Syed Nazrul Islam Bridge
5. Sculpture “Jagroto Bangladesh”
6. Gas Supply Network

Power Generation Units of Company at a glance is shown below:

Unit	Date of Commission	Capacity (MW)		Running Hour (February 2012)
		Commissioned	De-rated (Present)	
Unit-1	17.07.1970	64	64	231,011.20
Unit-2	08.07.1970	64	64	208,955.30
Unit-3	17.12.1986	150	105	190,897.65
Unit-4	04.05.1987	150	140	185,852.30
Unit-5	21.03.1988	150	140	170,610.82
GT-1	15.11.1982	56	40	155,522.39
ST	28.03.1984	34	18	91,159.04
GT-2	23.03.1986	56	40	183,647.05
Gas Engine	30.04.2011	53	53	5,618.00
Total		777	731	

Present Generation Plant & Substation of APSCL:



Unit-1 & 2 (2×64 MW)



Unit-3, 4 & 5 (3×150MW)



GT-1, GT-2 & ST (146 MW CCPP)



50 MW GEPP



132KV & 230KV Sub-station of APSCL

Infrastructure

- 132KV Grid Network – 23 Bays
- 230KV Grid Network – 13 Bays
- Gas Supply Network
- Rail Connectivity
- Road Connectivity
- River Connectivity with favorable navigability
- Jetty Crane, Limited upto 220 Tons
- Training Center equipped with Workshop facilities.
- Electrical & Mechanical Workshop facilities

Residence and Others:

- Housing - 546 flats
- Single - 80 flats
- School - upto X classes
- Medical Center
- Mosque
- Temple
- Club
- Auditorium
- Officers Dormitory- 36 flats
- Rest House- 8 Double Suits & 6 Single Suits

APSCL Land:

- Plant Area = 126.33 Acre
- Residential Area = 87.37 Acre
- Project Area = 23.14 Acre
- Rental Plant Area = 8.16 Acre
- Ditch Type Land = 18.55 Acre
- **Total = 263.55 Acre**

Human Resources:

- Graduate Engineer – 50
- Diploma Engineer – 59
- HRD Division – 3
- HRM Division – 8
- Security Division – 26
- Accounts Division – 10
- Skilled and Semi Skilled Technical Staff – 361

- Total Regular Employees – 517
- Total Temporary Employees – 47
- Grand Total – 564**

Other Security Forces Residing in APSCL:

- Ansar – 28
- Army – 35

132KV Substion:

Among the APSCL generation plants unit-1, unit-2, GT-1, GT-2, ST, 50 MW GEPP & Rental 55 MW Precision Energy Ltd. are connected with the 132kv sub-station. Other transmission lines which are connected with this 132kv sub-station are:

- Shajibazar-3
- Brahmanbaria-1,2
- Ghorashal-1,2
- Kishorgonj-1,2

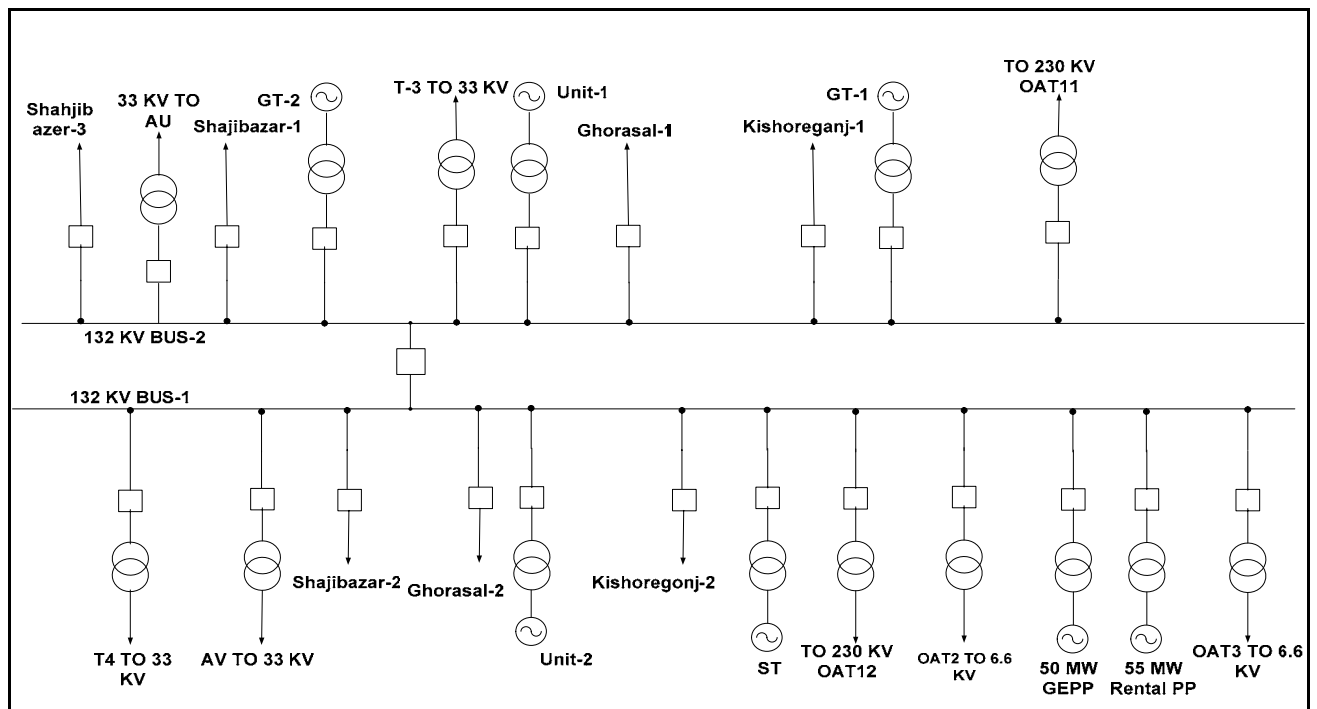

Single line diagram of 132KV Sub-station

230KV Sub-station:

Among the APSCL generation plants unit-3, unit-4, unit-5 and Rental 53 MW United Power Plant & 80 MW Aggreko Power Plant are connected to the 230kv sub-station. Other transmission lines which are connected with this 230kv sub-station are:

- Comilla – 1, 2
- Ghorashal-1,2
- Serajganj-1,2

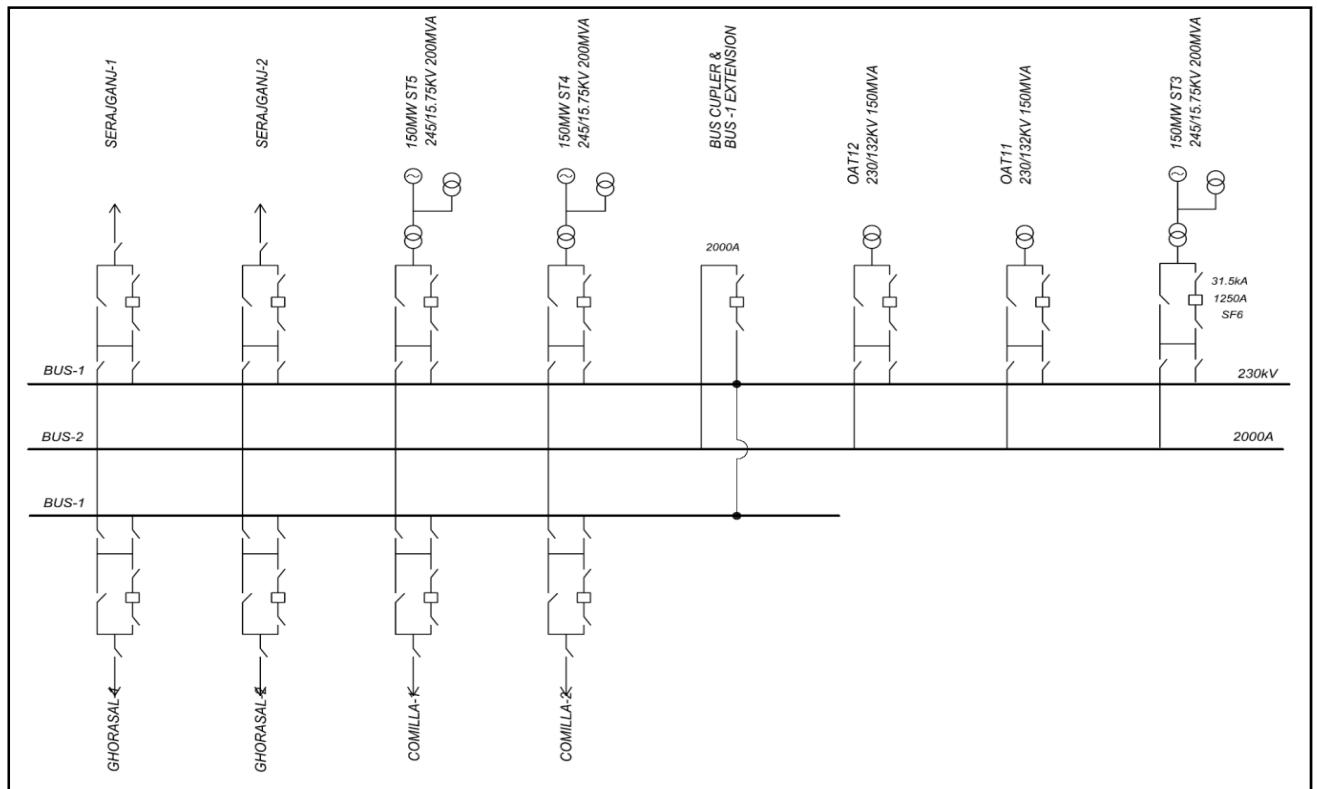

Single line diagram of 230KV Sub-station

APSCCL's Five-years Financial Review

Particulars	Unit	2010-11	2009-2010	2008-2009	2007	2006
Paid up Capital	Tk.	1,000,000	1,000,000	1,000,000	1,000,000	1,000,000
Net Fixed Asset	Tk.	18,943,313,329	16,704,265,898	12,520,449,953	13,552,995,202	14,121,937,439
Sales Revenue	Tk.	6,621,164,145	6,258,110,680	4,919,618,220	4,114,697,139	4,106,186,999
Profit before tax	Tk.	962,250,119	391,549,048	50,356,831	48,436,701	4,929,335
Profit after tax	Tk.	616,341,270	250,049,049	29,724,108	46,436,701	3,929,335
Current Assets	Tk.	6,136,279,874	4,270,195,331	2,912,469,366	8,309,150,603	7,094,548,341
Current Liabilities	Tk.	3,389,745,581	289,776,843	167,469,282	6,104,670,991	5,016,875,472
Financial Ratios						
Return on Average Net Assets	%	7.43	4.48	2.79	2.99	3.13
Debt Service Coverage Ration	Times	3.54	2.22	1.17	1.14	1.01
Debt Equity Ratio	Ratio	77:23	78:22	81:19	82.18	84:16
Average Collection Period	Month	4.25	3.55	20	20	16
Current Ration	Ratio	1.81:1	1.50:1	1.37:1	1.36:1	1.41:1

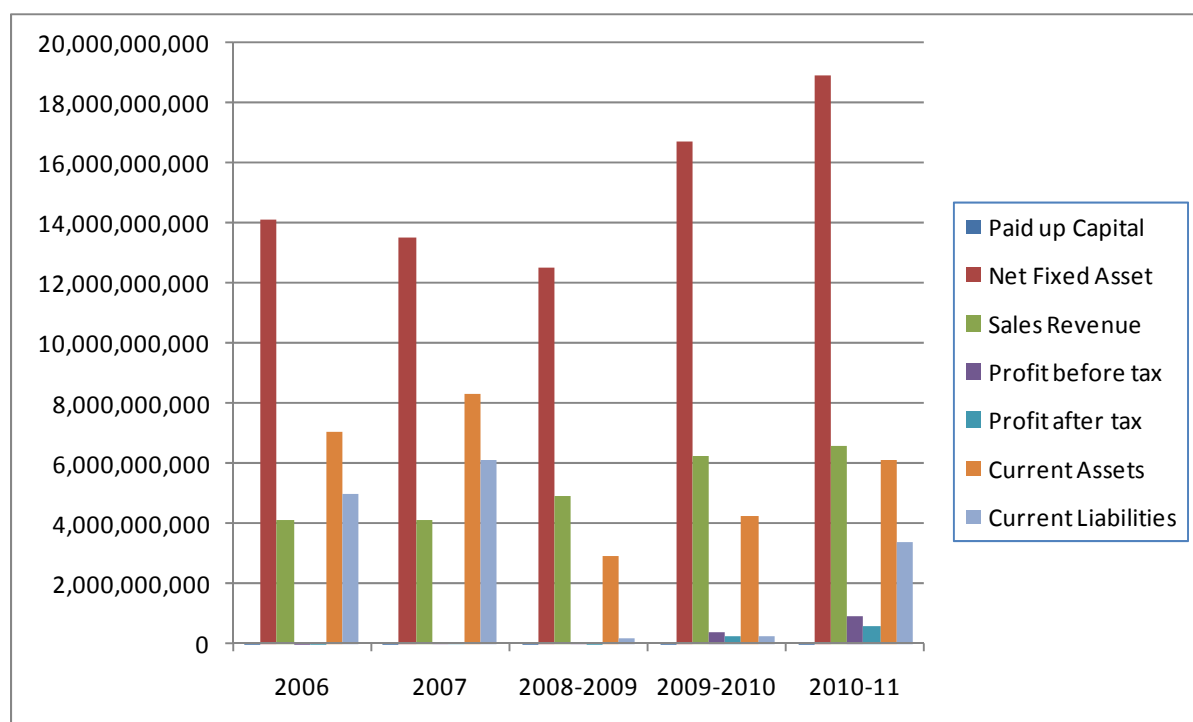

Last 5 years Financial Statistics of the Company

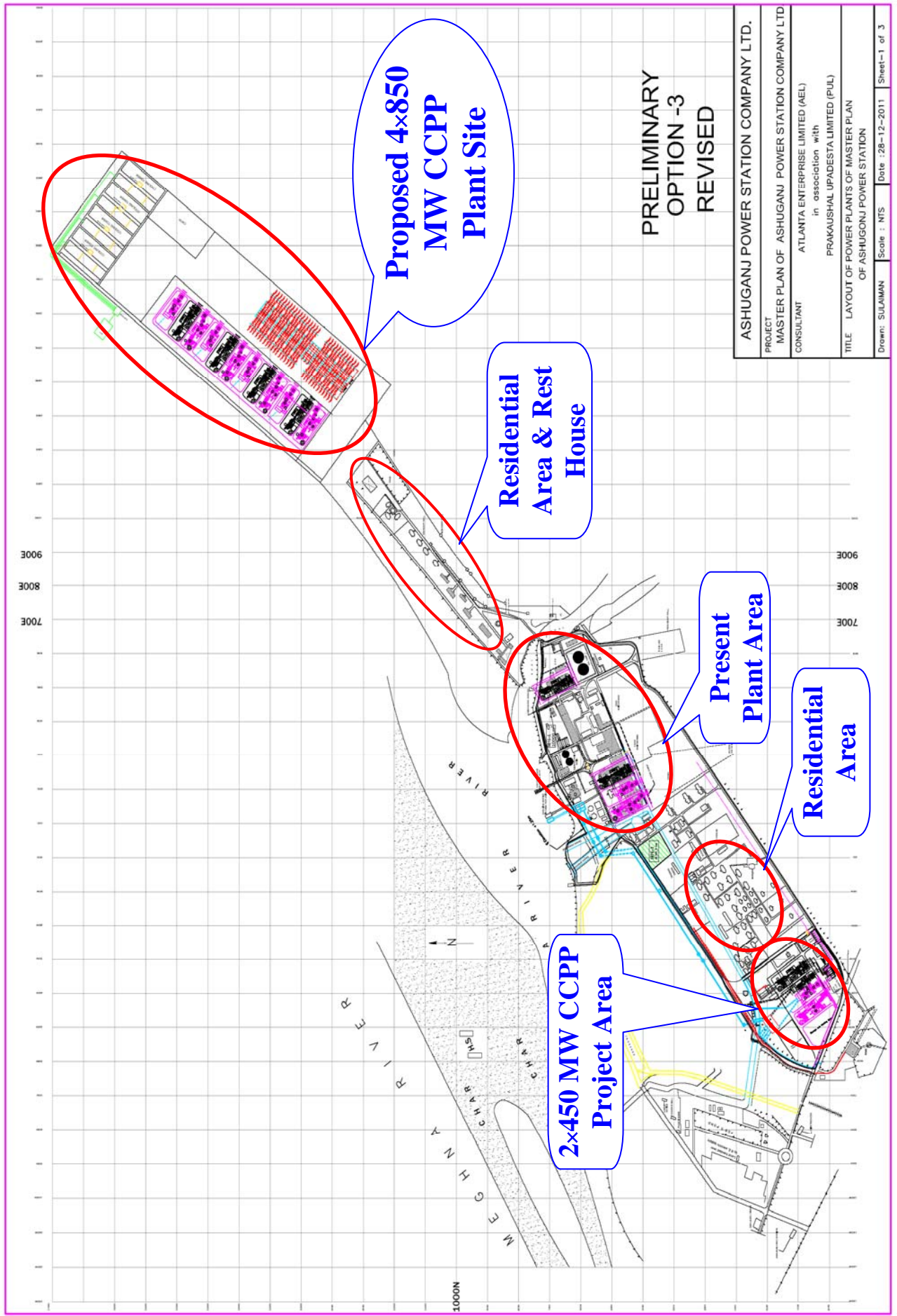

**PRELIMINARY
OPTION -3
REVISED**

ASHUGANJ POWER STATION COMPANY LTD.	
PROJECT	MASTER PLAN OF ASHUGANJ POWER STATION COMPANY LTD
CONSULTANT	ATLANTA ENTERPRISE LIMITED (AEL) in association with PRAKAUSHAL UPADESTA LIMITED (PUL)
TITLE	LAYOUT OF POWER PLANTS OF MASTER PLAN OF ASHUGANJ POWER STATION
Drawn: SUJAMAN	Scale : NTS
Date : 28-12-2011	Sheet-1 of 3

**Generation Plants, Projects & Residential Areas
of Ashuganj Power Station Company Ltd.**

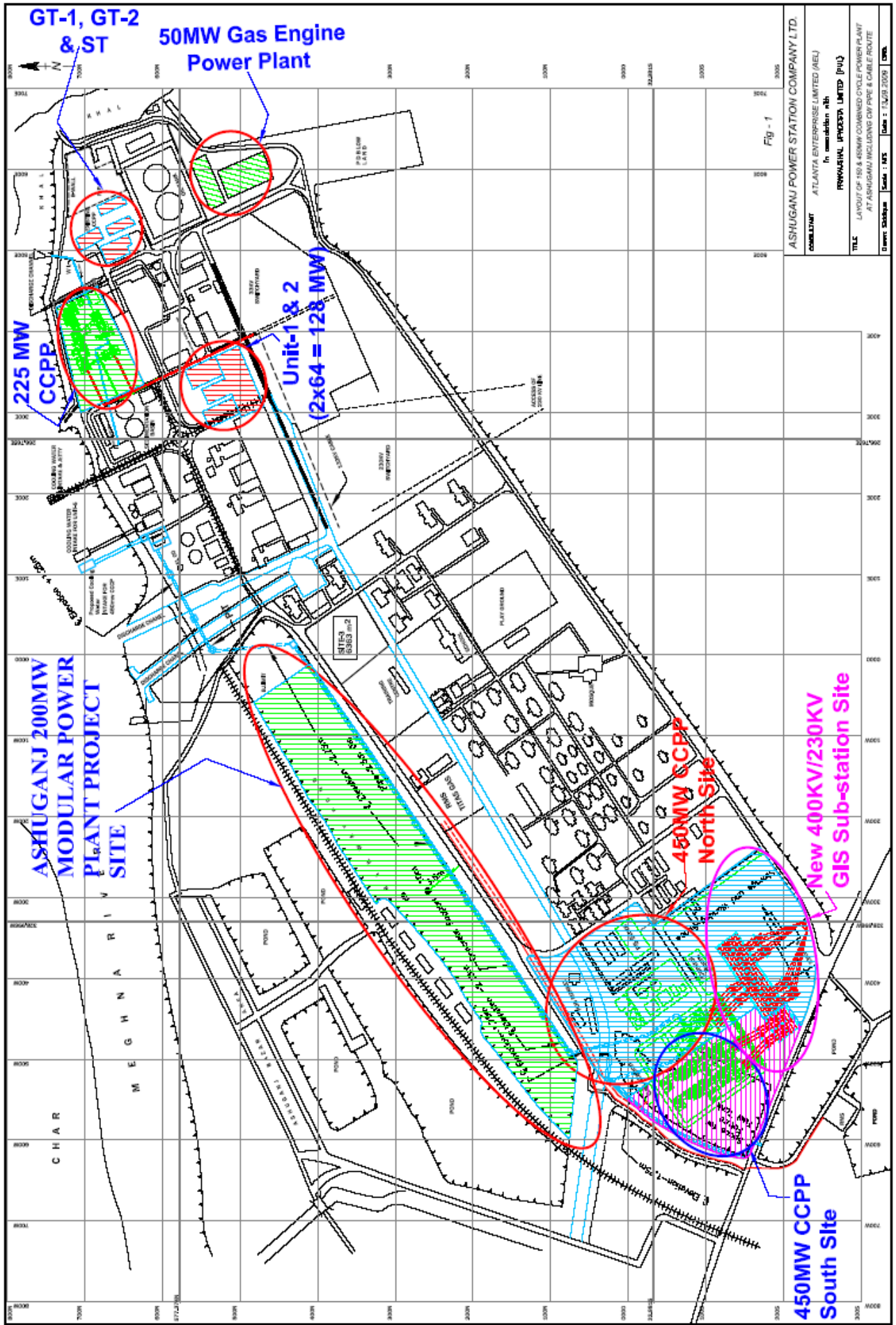

ASHUGANJ POWER STATION COMPANY LTD.	
CONSULTANT	ATLANTA ENTERPRISE LIMITED (AEL) In association with POWERWAL POWER LIMITED (PWL)
TITLE	LAYOUT OF 150 & 450MW COMBINED CYCLE POWER PLANT AT ASHUGANJ INCLUDING CWP PIPE & CABLE ROUTE
Drawn: Siddique	Scale: 1:500 2008 Date: 14.03.2008 DWG

Project areas of Ashuganj Power Station Company Ltd.

Completed Project of the Company:

50 MW Gas Engine Power Plant:

To meet the extra demand of electricity of the country the Government of Bangladesh planed to establish more power generation units as early as possible. As guided by the Government of Bangladesh (GOB) Ashuganj Power Station Company Ltd. took a project in 2010 to establish a power generation unit having a generation capacity of 50MW, financing with its own fund. To fulfill this project an agreement was signed with the M/S TSK, Spain (EPC) on 25th July of 2010. The new generation unit has started its commercial operation at 53MW load from 30th April of 2011. The brief description of the project is given below:

EPC Contract Price	: USD 40,925,000+BDT 202,914,500
Financer	: APSCL (Standard Chartered Bank)
EPC Contractor	: TSK, Spain
Contract agreement signing date	: 25 July 2010
Implementation Date	: 233 Days
Commercial operation date	: April 30, 2011
Generation capacity	: 53 MW
Engine Model	: GE, J 620 GS-F101
No. of Engine	: 16
Capacity of Each Engine	: 3332 KW
Country of Origin	: Austria
Fuel	: Natural Gas
Project Area	: 9,080 Sq. Meter



50MW Gas Engine Power Plant

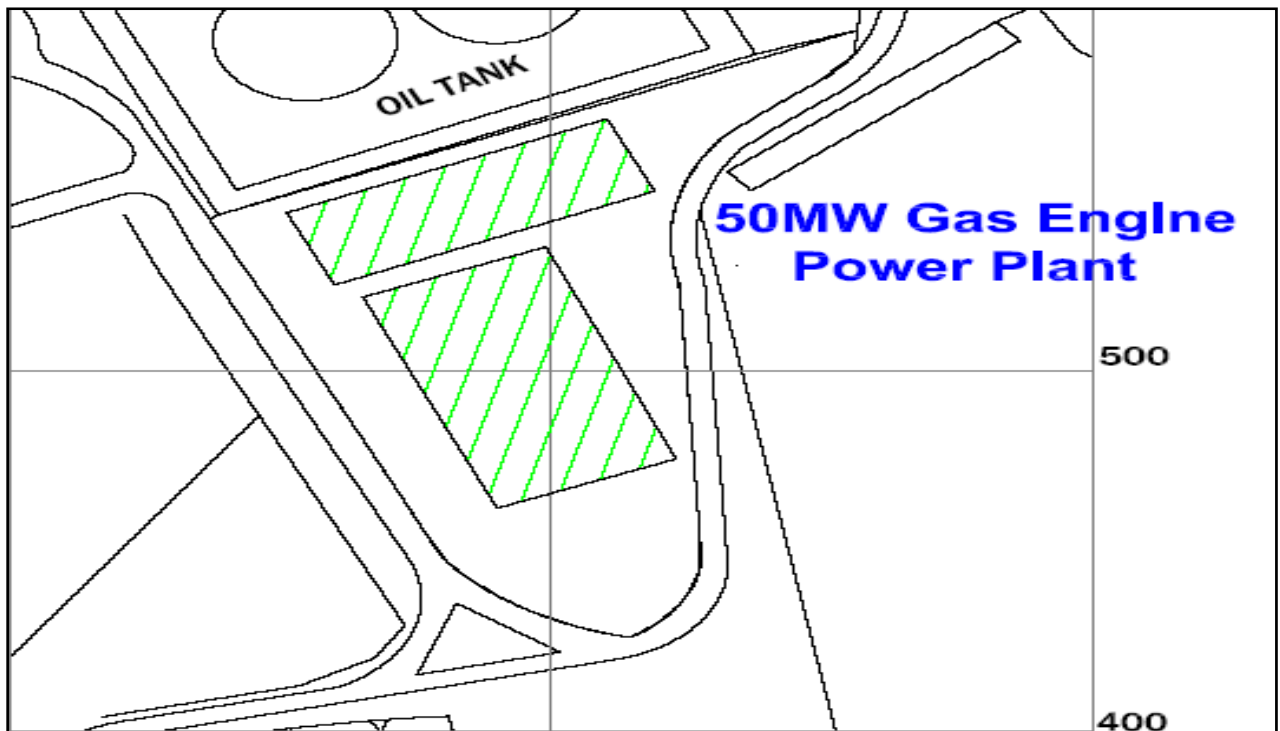

50MW Gas Engine Power Plant Project area

APSCCL Master Plan-2012:

Generation Plan of APSCCL: 2011 to 2015

At present the established generation capacity of the company 777 MW. A plan has been taken to increase the total established generation capacity to 2102 MW by 2015. According to this plan presently 4 projects is going on. These projects are:

1. 225 MW Combine Cycle Power Plant Project
2. 450 MW Combine Cycle Power Plant (South) Project
3. 450 MW Combine Cycle Power Plant (North) Project
4. 200±10% MW Modular Power Plant Project

Present Development Status of the Projects:

1. 225 MW Combine Cycle Power Plant Project:

APSCCL has decided to establish a 225MW Combine Cycle Power Plant with its own fund. According to this plan an agreement was signed between APSCCL and The Consortium of Hyundai Engineering Co. Ltd. and Daewoo International Corporation, Korea on 5th October 2011. The brief description of the project is given below:

Generation Capacity : 225 MW
 EPC Contract Price : USD 61,970,240 + UERO 60,362,742
 + BDT 2,530,772,664
 ECA Backed Financer : ECA Support
 Mandated lead Arranger : Standard Chartered Bank
 Contrat Agreement : 5 October, 2011
 Signing Date
 EPC Contractor : The Consortium of Hyundai
 Engineering Co. Ltd. and Daewoo
 International Corporation, Korea
 Expected date of completion : April, 2014
 Project duration : 25 Month
 Fuel : Natural Gas
 Present Status : Geotechnical Investigation, Topographic
 Survey and Bathymetric Survey have
 finished on 10 February 2012. Payment
 Guarantee is subjected to MoF.

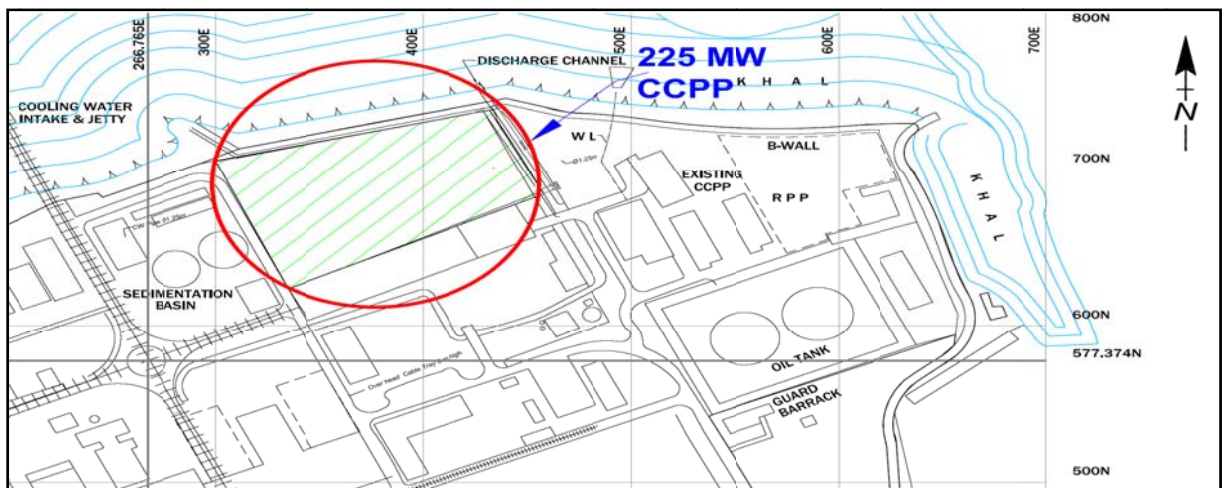

225 MW CCPP Project Area



Present Status of 225 MW CCPP Project Area

2. **450 MW Combine Cycle Power Plant (South) Project:**

Currently APSCL has planned to establish another 450MW CCPP unit with ECA financing. The technical evaluation of the bid document has finished and the financial evaluation is going on. The key points of the projects are as below:

Generation Capacity	: 375 MW
Estimated Cost of Project	: BDT 3,333.00 Crore
Expected Project financing	: ECA Backed project finance
Expected contract Agreement	: June 2012
Expected date of completion	: December 2014
Fuel	: Natural Gas
Current Status	: EPC contractor selection is in process



450MW CCPP (South) Project Area



Present Status of 450MW CCPP (South) Project Area

3. **450 MW Combine Cykel Power Plant (North) Project:**

With the financing of ADB & IDB APSCL has taken another project to establish a 450MW CCPP Plant. The tender of this project will be invited very soon. The brief description of the project is given below:

Generation Capacity	: 450 MW
Estimated Cost of Project	: BDT 3,400.02 Crore
Project Finance	: ADB & IDB
Expected date of completion	: October 2015
Current Status	: Engagement of Consultant is in process
Fuel	: Natural Gas

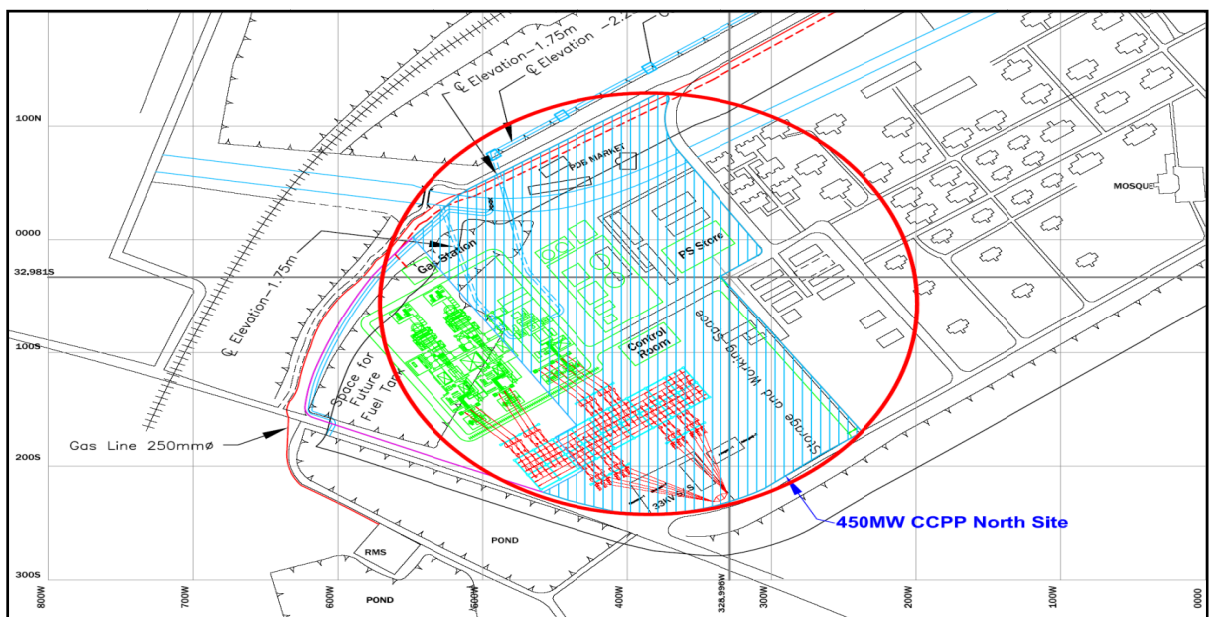

450 MW Combine Cykel Power Plant (North) Project Area



Present Status of 450 MW Combine Cykel Power Plant (North) Project Area

4. **200±10% MW Moduler Power Plant Project:**

To increase the total generation of the company within a very short time a decision has been made to establish a 200MW Modular Power Plant. The tender of this project has been invited. A brief description of the project is given below:

Geneation Capacity	: 200±10% MW
Project Finance	: Build Own and Operate basis (BOO), according to the Private Sector Power Generation Policy (PSPGP) 1996.
Life time	: 15 years
Tender invitation date	: 26 February 2012
Last date of tender receiving	: 26 May 2012
Expected project completion date	: July 2013
Fuel	: Natural Gas
Current Status	: Tender Invited

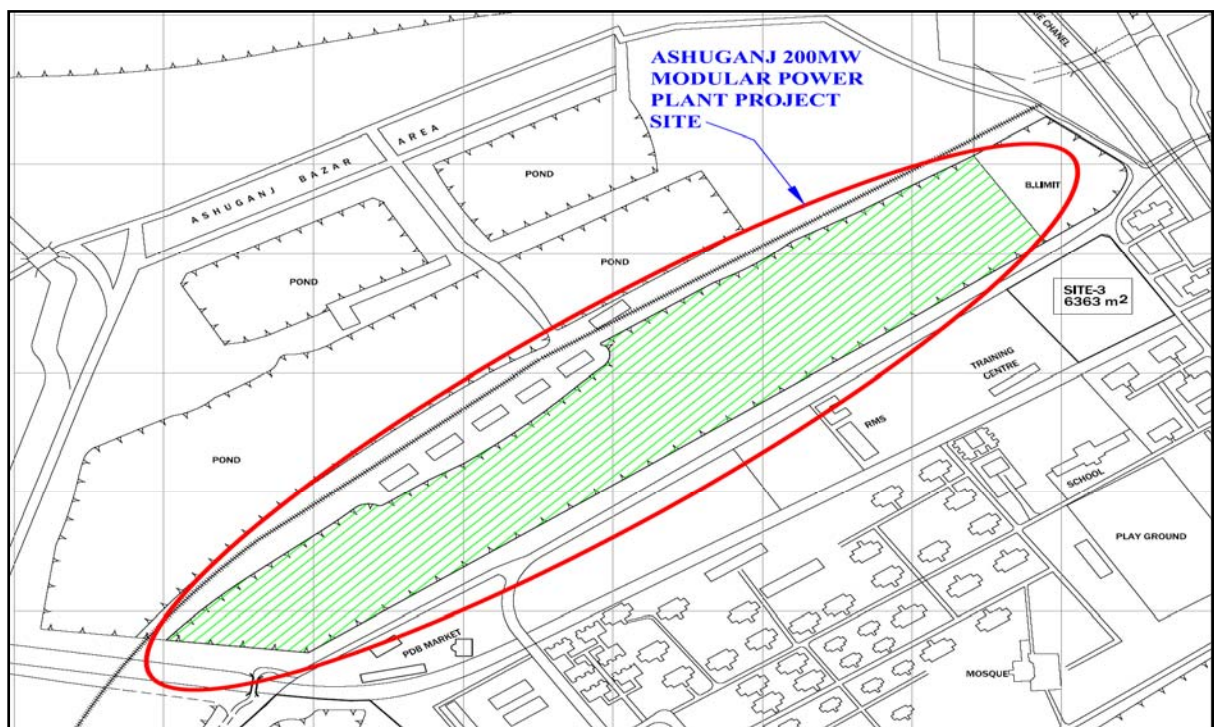

200±10% MW Moduler Power Plant Project Area

230KV/400KV GIS Sub-station:

For the power evacuation of the newly installed plant a plan has been made to establish a 230kV/400kV GIS (Gas Insulated Sub-station). In this new sub-station there will be 8 bays with 400kV and 9 bays with 230kV bus bar, in total 17 bays will be there. Single line diagram of this sub-station is as below:

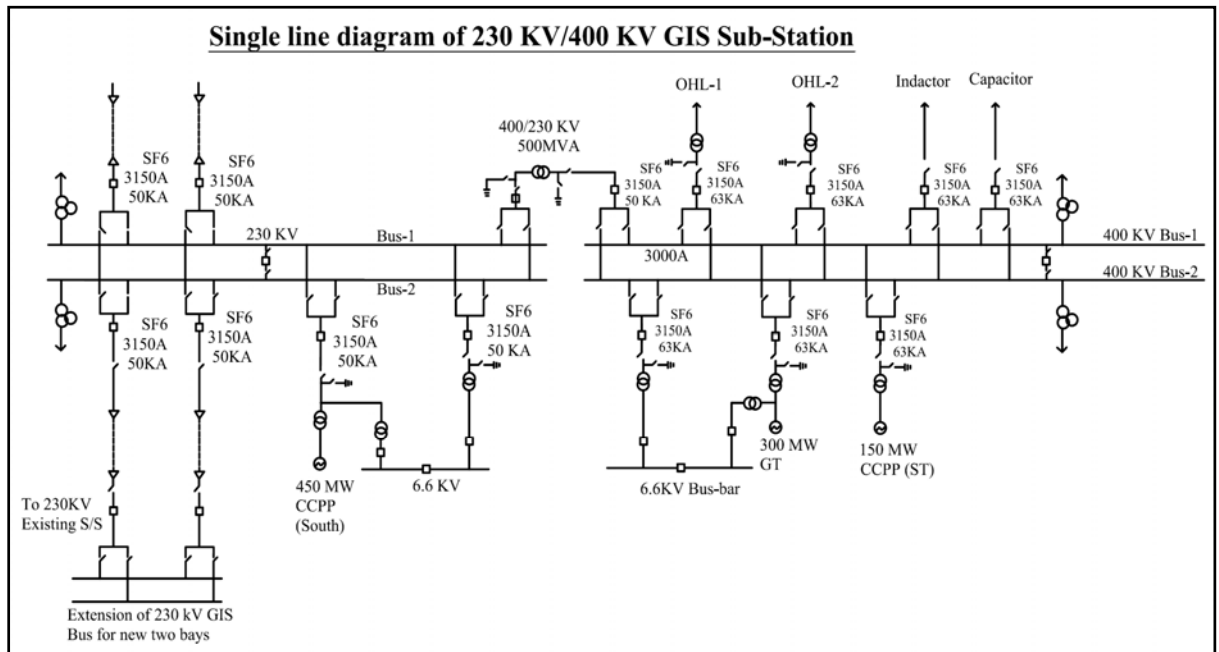

230KV/400KV GIS (Gas Insulated Sub-station) Sub-station

Moreover to connect this new sub-station with the 230kV grid sub-station an extension plan has been taken to extend the existing 230kV sub-station. The extension area of 230kV sub-station is shown below:



Proposed extension area of 230KV Sub-station (West site Residential Building of Present 230KV Sub-station)

For the extension of 230kV sub-station these residential building (shown above) will be removed. Six (6) bays will be connected with this extended substation.

Generation Plan of APSCL: 2011 to 2015

From 2011 to 2015 the total established generation of the company will be 2102MW and by this time the company's generation figure will be as below:

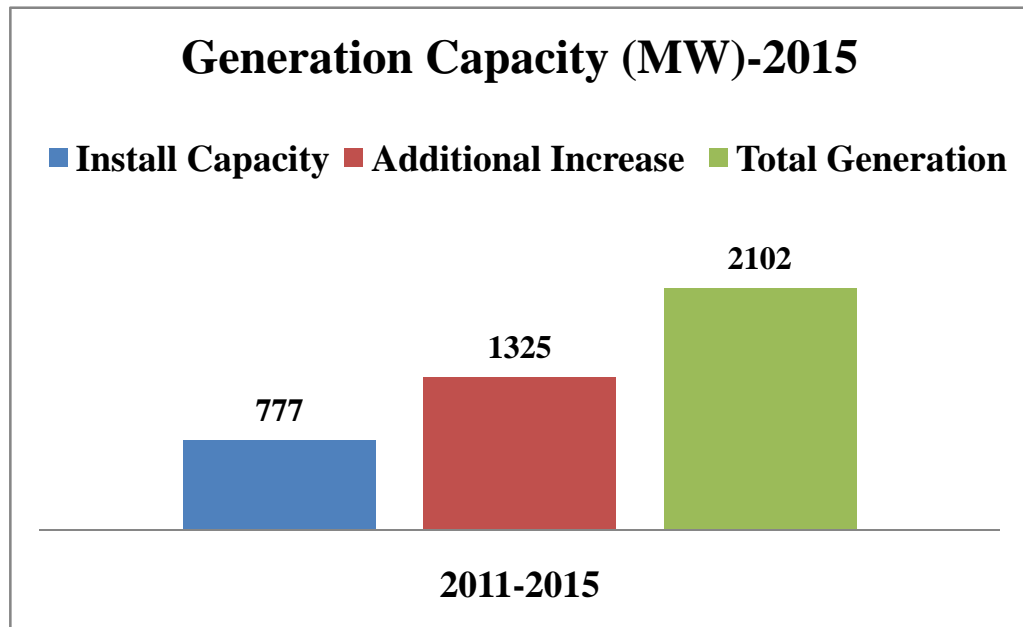

The company total generation graph from 2011 to 2015

Name of the Projects:

1. 225 MW Combine Cycles Power Plant Project
2. 450 MW Combine Cycles Power Plant (South) Project
3. 450 MW Combine Cycles Power Plant (North) Project
4. 200±10% MW Modular Power Plant Project

Generation Plan of APSCL-2016 to 2020:

Atlanta Enterprise Ltd. in association with the Prokousal Upadesta Ltd. and Institute of Water Modeling has prepared a master plan for Ashugonj Power Station Company Ltd. According to that master plan the following projects has been considered for the year of 2016 to 2020.

1. Retirement of unit 1 & 2 ($2 \times 64 = 128$ MW) and establishment of future 450MW CCPP Plant.
 2. Retirement of 146 MW CCPP (GT-1, GT-2 & ST) (2017) and establishment of $2 \times 150 = 300$ MW Gas turbine power pant (Piking plant) (2020).
 3. As per the Master plan of APSCL, establishment of 2×850 MW CCPP Plant (new-1 & new-2) in fully new site (site-1).
- 1. Retirement of unit 1 & 2 ($2 \times 64 = 128$ MW) and establishment of future 450MW CCPP Plant:**

Unit-1 and unit-2 will be removed from its site by 2016 and this site will be prepared for future 450MW CCPP. The work for clearing the site of existing 128MW ST will be started in due time.

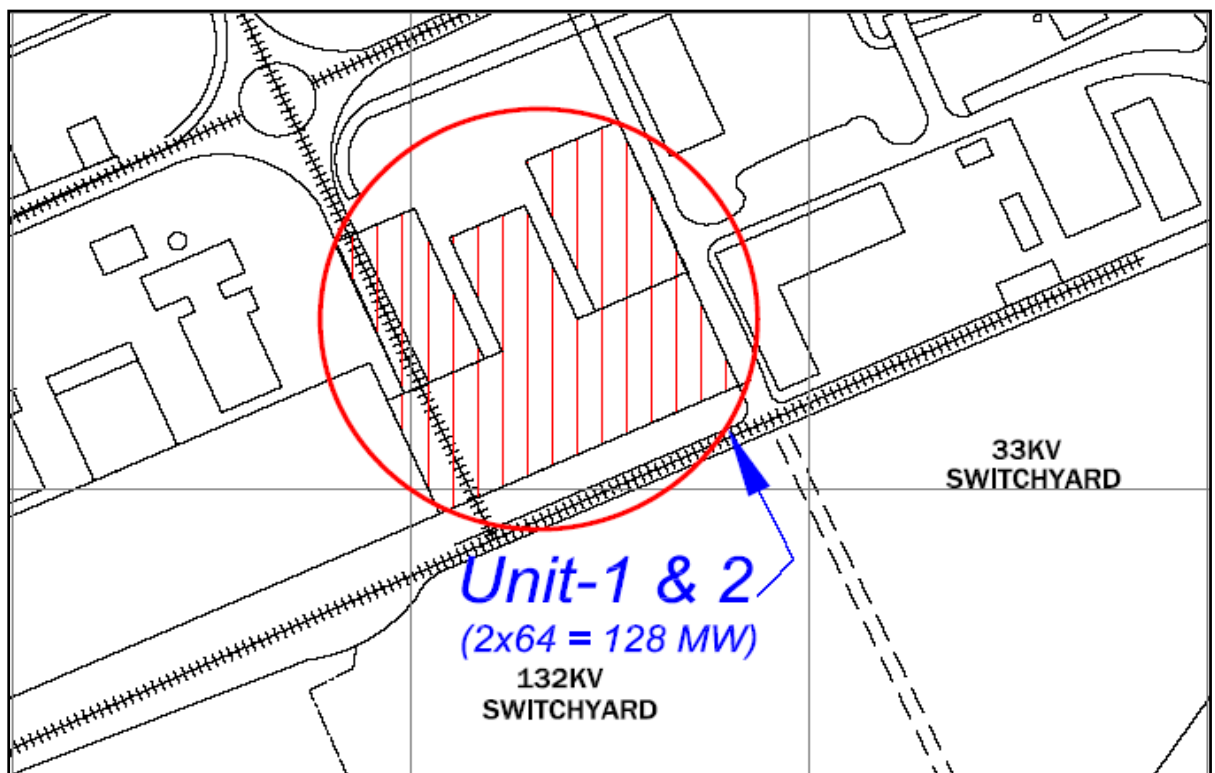

Unit-1&2 ($2 \times 64 = 128$ MW)

2. Retirement of 146MW CCPP (GT-1, GT-2 &ST) plant and establishment of $2 \times 150 = 300$ MW GT (peaking plant) as the replacement of 146 MW CCPP.

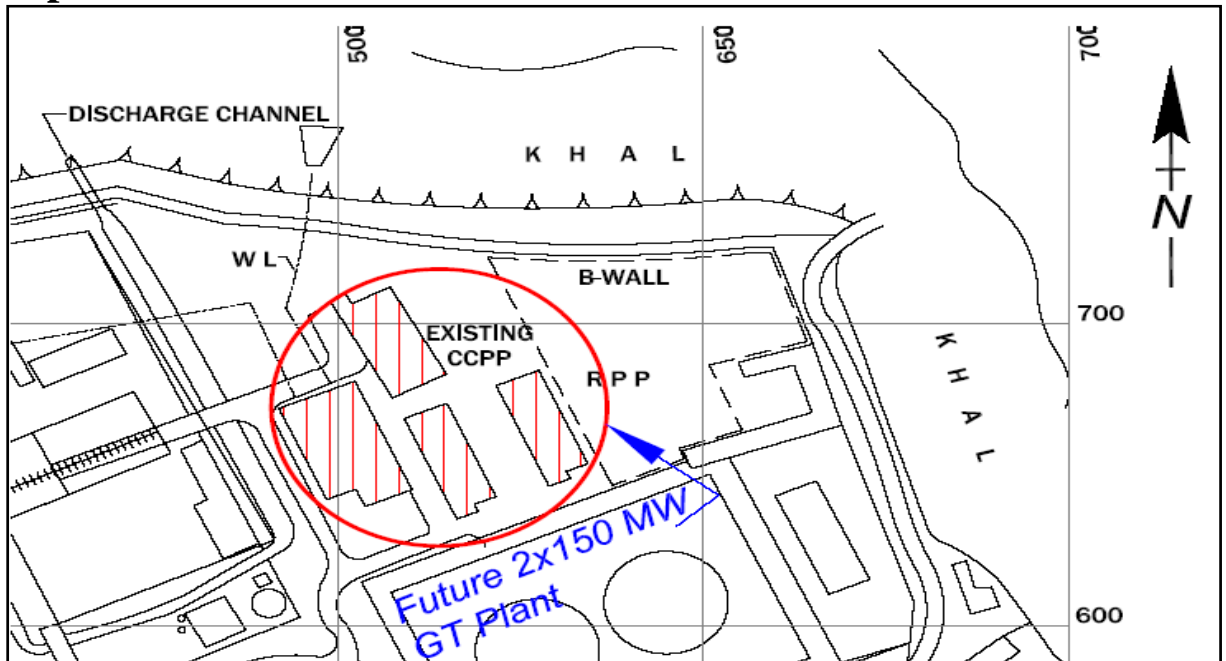

$2 \times 150 = 300$ MW GT POWER PLANT SITE

3. 2×850 MW CCPP (New-1 & New-2) will be constructed in new site within 2020.

Currently 39% of total generated gas is used for power generation. To meet up the demand for power of the country more gas based power plant projects are in progress. Due to that demand and use of gas is increasing day by day. Alternate fuel is considered for these two new projects (2×850 MW CCPP) to reduce dependency on gas. 100 acres of land is going to be acquired for these projects.

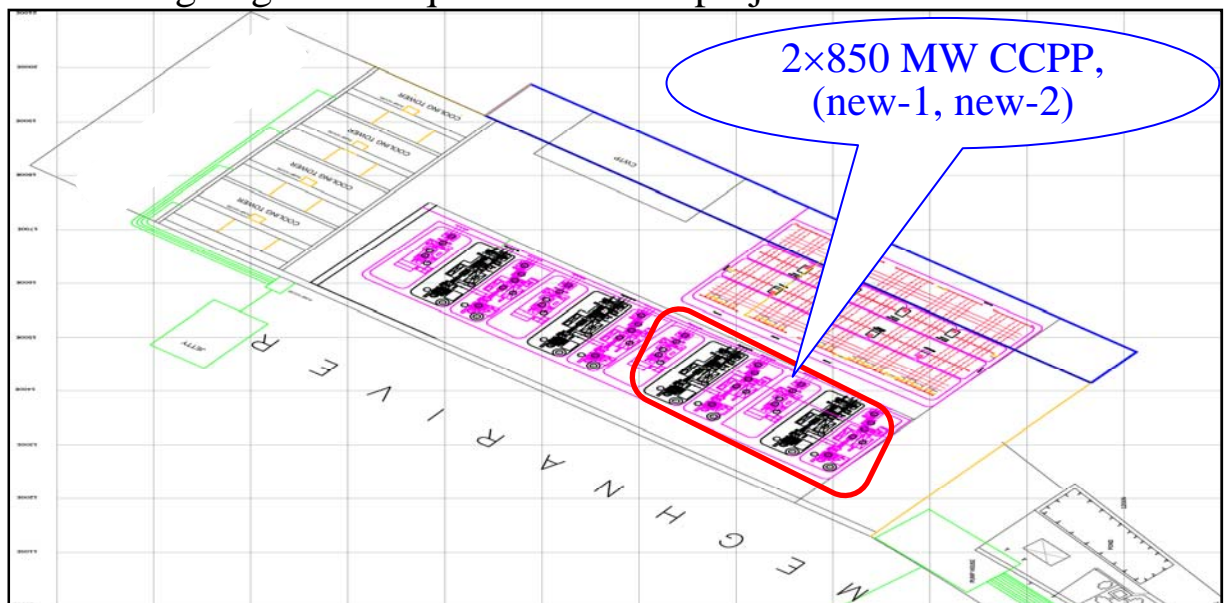

4×850 MW CCPP Project Site

Generation Plan of APSCL-2016 to 2020:

From 2016 to 2020 the total established generation of the company will be 3828 MW and by this time the company's generation figure will be as below:

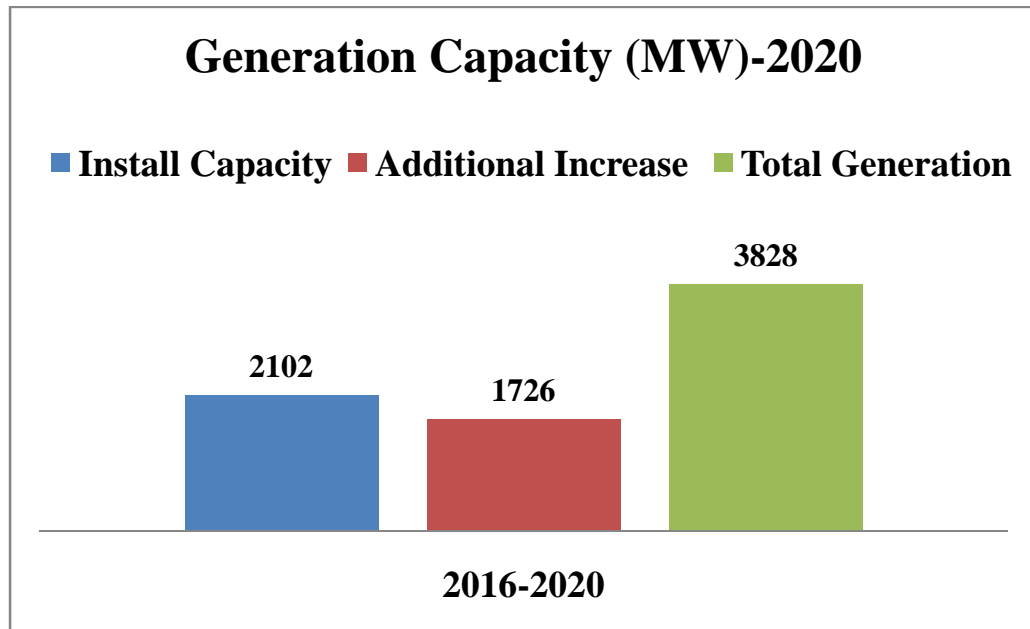

The company total generation graph from 2016 to 2020

Name of the projects:

1. Retirement of Unit-1&2 ($2 \times 64 = 128$ MW ST)
2. Retirement of 146 MW CCPP (GT-1, GT-2, ST) (2017) and will be replaced by $2 \times 150 = 300$ MW Gas Turbine Power Plant (Peaking Plant) (2020).
3. According to APSCL Master Plan 2×850 MW CCPP (New-1 & New-2) will be constructed in new site (Site-1).

Generation Plan of APSCL-2021 to 2025:

1. Unit-3, 4 & 5 ($3 \times 150 = 450$ MW) will be replaced by new 850 MW CCPP within 2023.
2. A new 450 MW CCPP will be constructed in place of old Unit-1 & 2, (128 MW ST).

1. **Unit-3, 4 & 5 ($3 \times 150 = 450$ MW) will be replaced by new 850MW CCPP within 2023.**

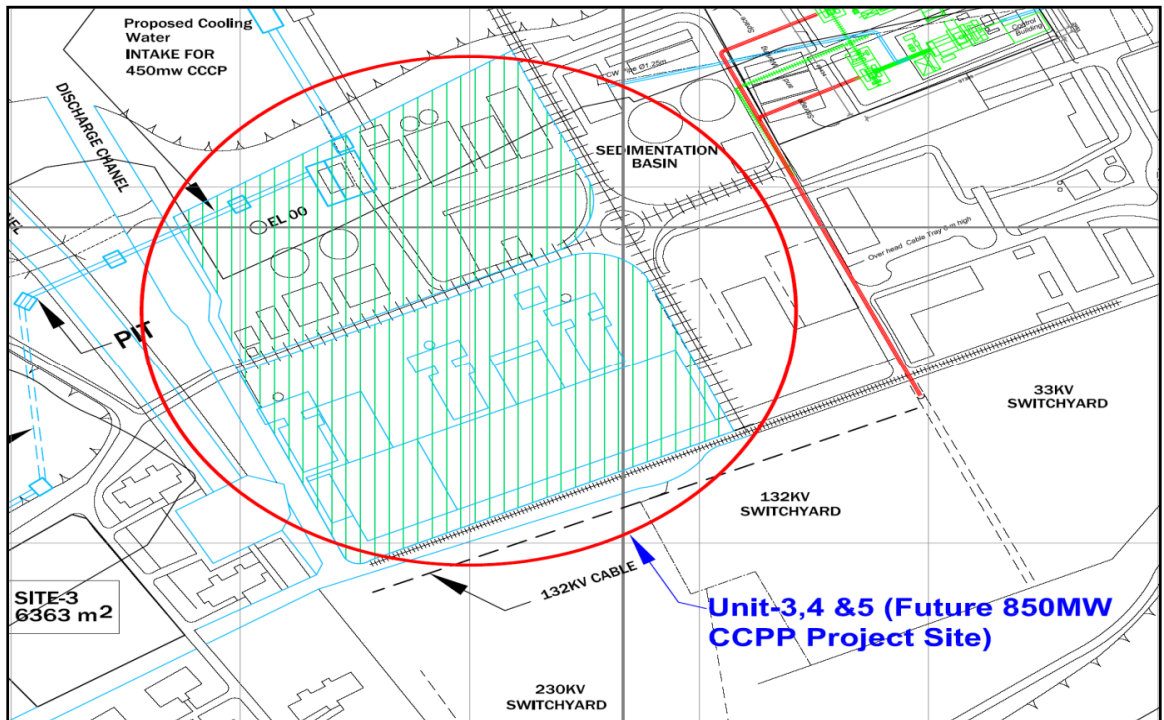

850 MW CCPP Site Area (Replacement of 450MW)

2. **A new 450 MW CCPP will be constructed in place of old Unit-1&2, (128 MW ST).**

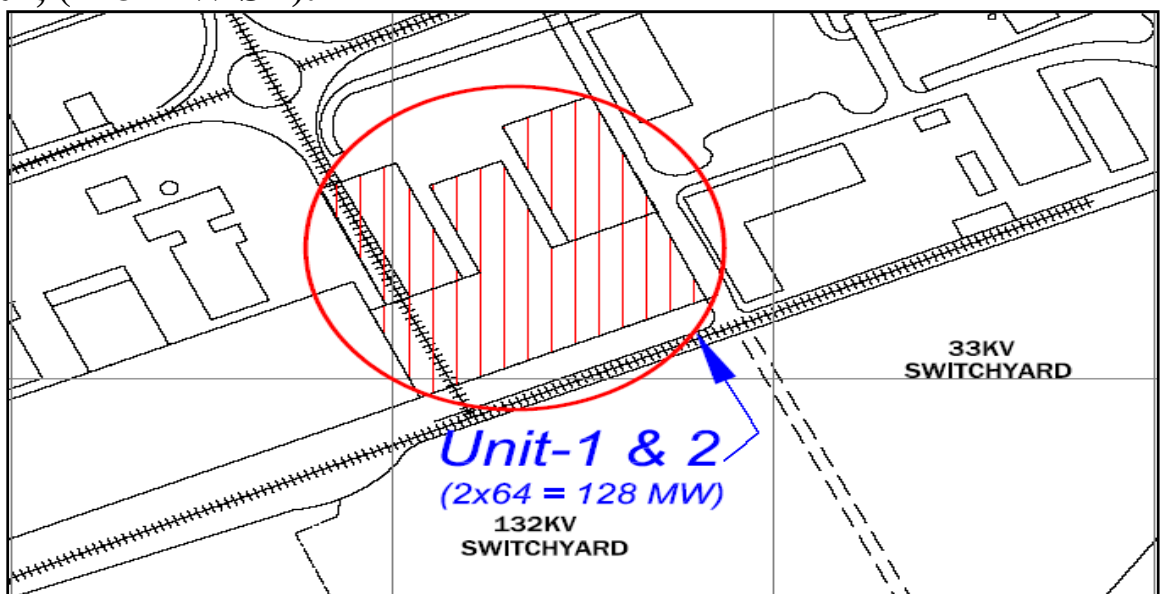

450 MW CCPP Site (Replacement of 128MW)

Generation Plan of APSCL-2021 to 2025:

From 2021 to 2025 the total established generation of the company will be 4678 MW and by this time the company's generation figure will be as below:

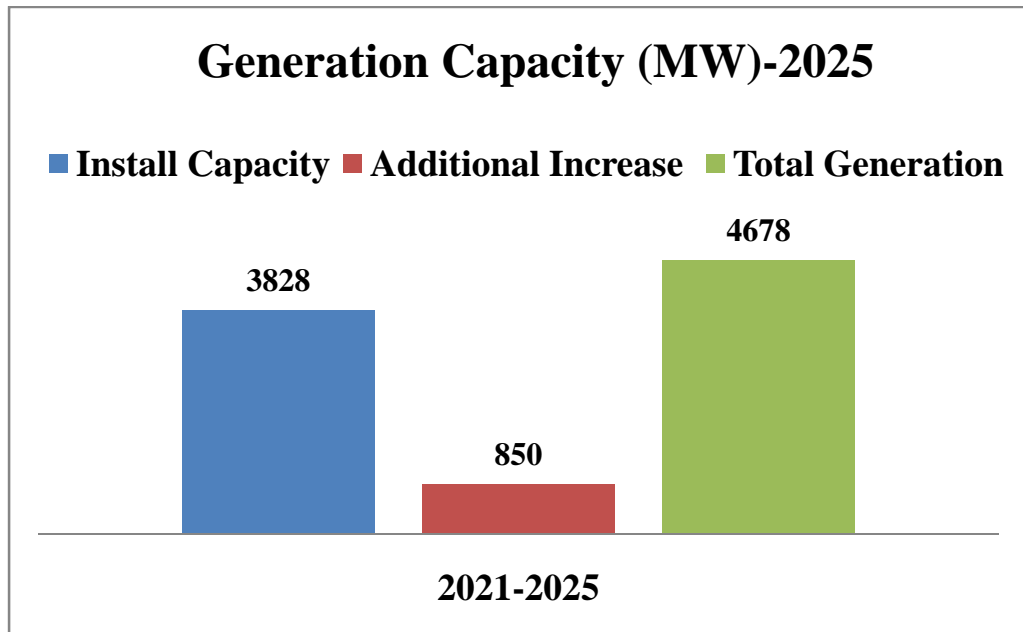

The company total generation graph from 2021 to 2025

Name of the projects:

1. 850 MW CCPP Project replacement of Unit-3, 4 & 5 ($3 \times 150 = 450$ MW ST).
2. 450 MW CCPP Project replacements of Unit-1&2, (128 MW ST).

Generation Plan of APSCL-2026 to 2030:

1. 2x 850 MW CCPP (New-3 & New-4) project.
2. Retirement of 50 MW Gas Engine Power Plant (2026).

1. Construction of 2x 850 MW CCPP (New-3 & New-4) project

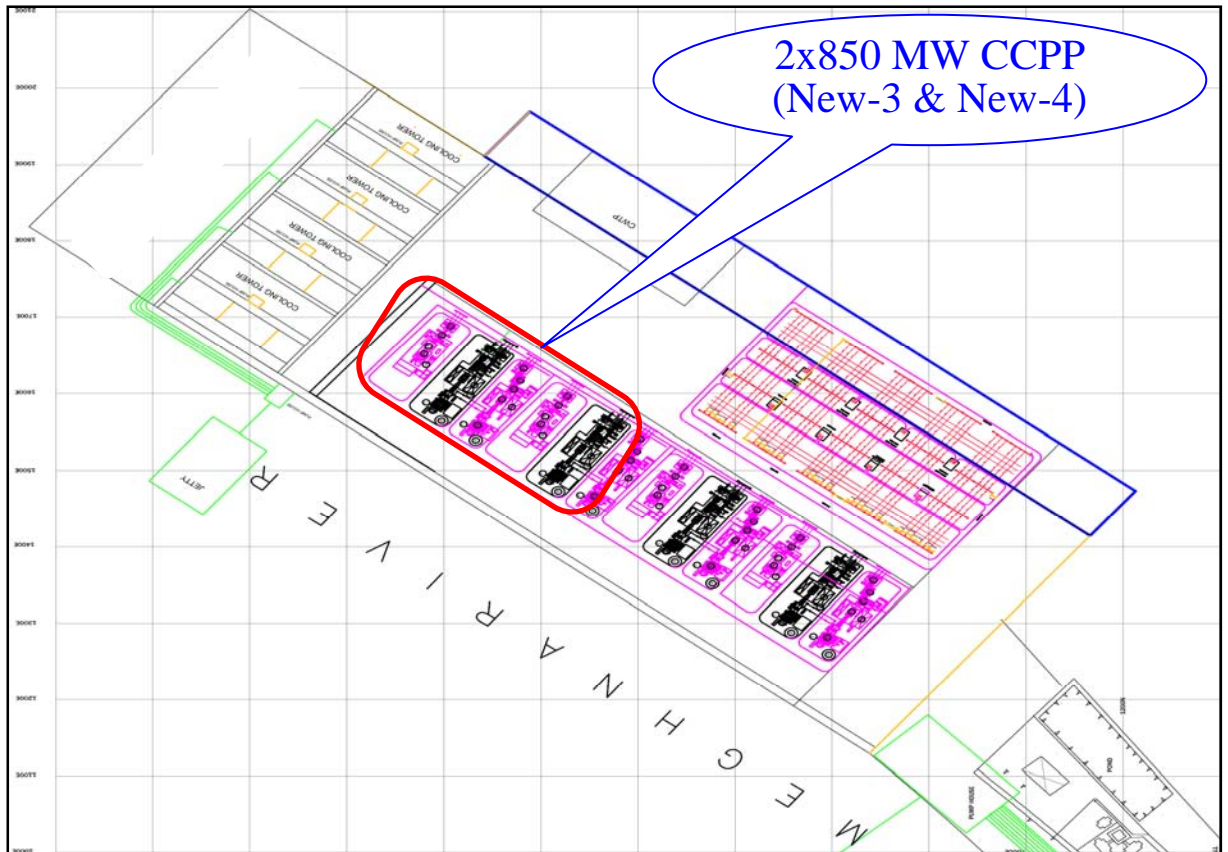

4x 850 MW CCPP Project Site.

2. Retirement of 50 MW Gas Engine Power Plant (2026).

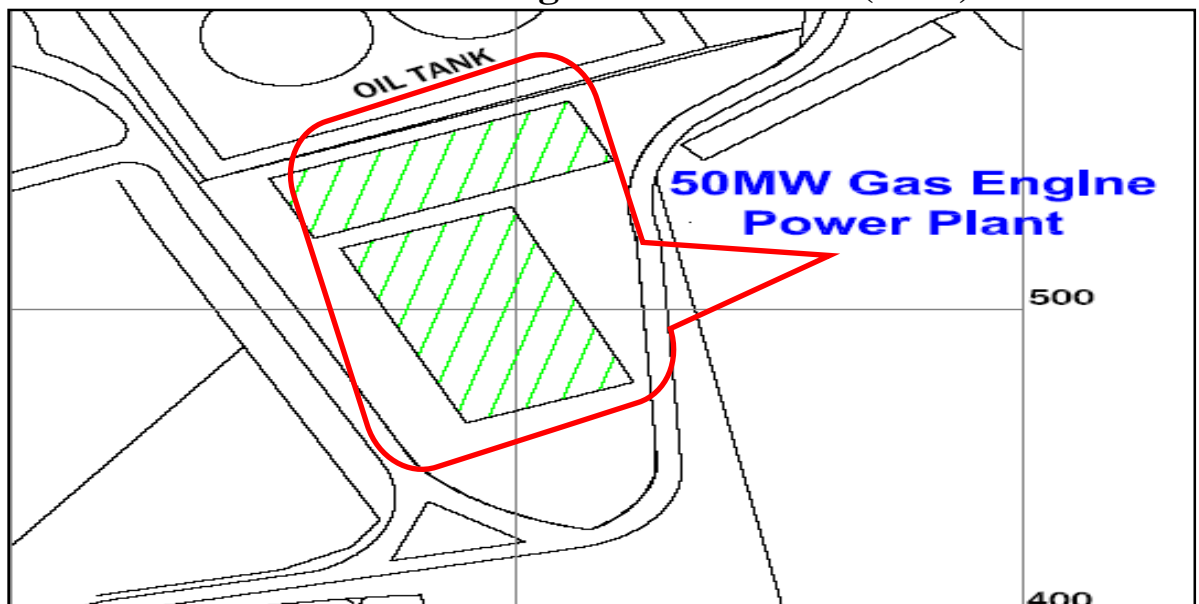

50 MW Gas Engine Power Plant site

Generation Plan of APSCL-2026 to 2030:

From 2026 to 2030 the total established generation of the company will be 6325 MW and by this time the company's generation figure will be as below:

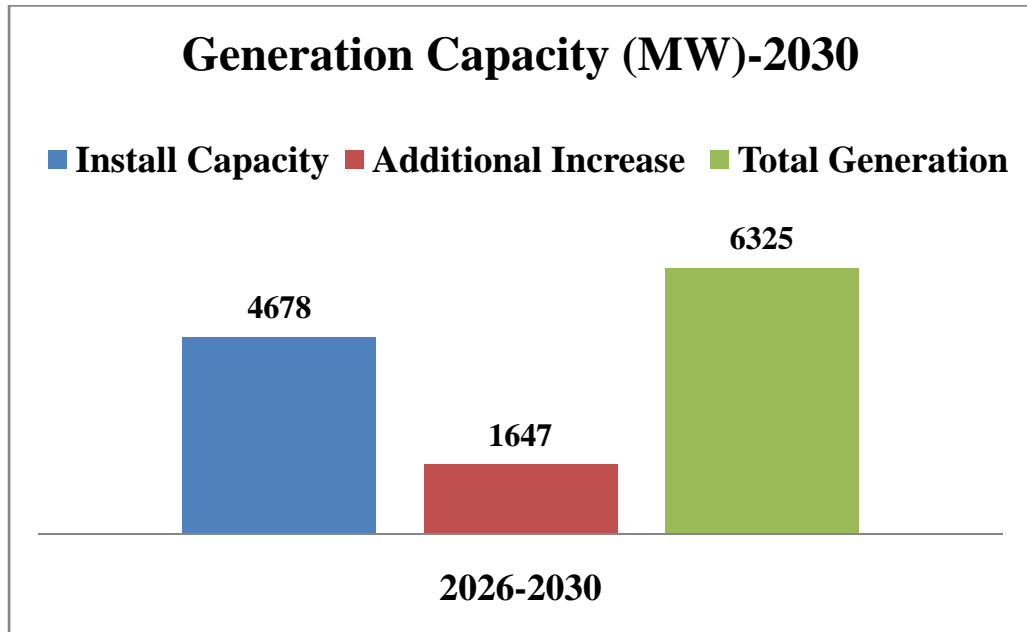

The company total generation graph from 2026 to 2030

Name of the projects:

1. 2× 850 MW CCPP (New-3 & New-4) project.
2. Retirement of 50 MW Gas Engine Power Plant (2026).

Generation Plan of APSCL up to 2030:

Year	New Plant	Retired Plant(Year)	Additional Generation (MW)	Total Generation (MW)
2011-2015	225 MW CCPP	-	1325	2102
	200 MW Modular			
	450MW CCPP (South)			
	450 MW CCPP (North)			
2016-2020	2×850 MW CCPP (New-1, New-2)	2×64 = 128 MW ST (Unit-1 & 2) (2016)	1726	3828
	2×150 = 300 MW Gas Turbine Picking Plant)	146 MW CCPP (GT-1, GT-2, ST) (2017)		
2021-2025	850 MW CCPP	3×150=450 MW (Unit-3,4 & 5) (2023)	850	4678
	450 MW CCPP			
2026-2030	2×850 MW CCPP (New-3, New-4)	50 MW GEPP (2026)	1647	6325

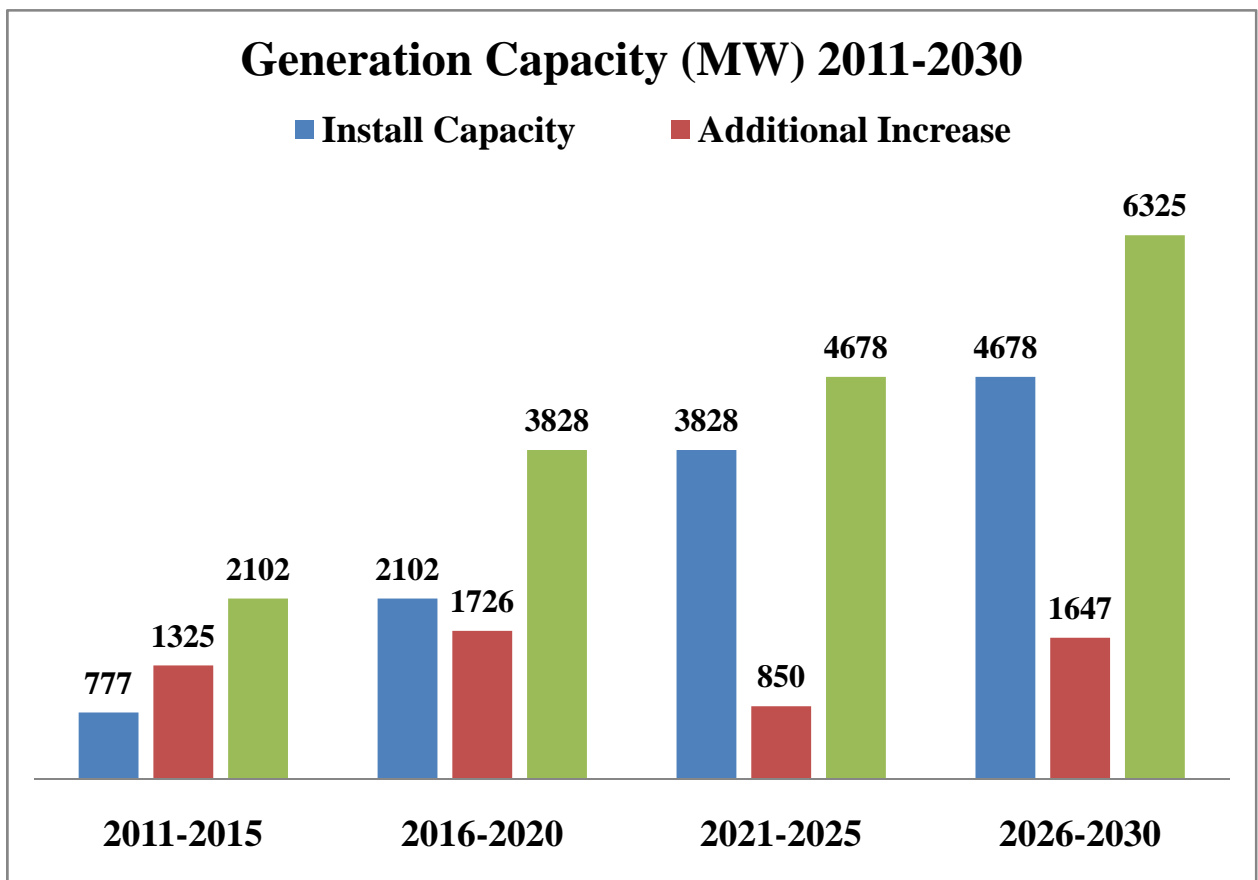

**Power Generation Graph of APSCL -2011 to 2030
(According to APSCL Master Plan-2012)**

Ashuganj as Power Generation HUB:

At present 4 power plant projects of APSCCL are in progress. Beside this there is a master plan to construct more power plants in future. At Ashuganj several IPP and Rental Power Plants are also situated. These IPP and Rental Power Plants evacuate power through National Power Grid connected to APSCCL. Additional land acquisition is required for future power plant projects. 220 acres of Government land located western side of Ashuganj Fertilizer and Chemical Company Ltd. can be a probable site for future power plant project. It is very urgent to reduce dependency on gas as fuel for power generation. In view of that a 1300 MW Coal Based Power Plant can be constructed on that 220 acres of land. APSCCL is going to implement news projects in view to become power generation HUB.

Satellite view of probable project site: 220 acres of Government land located western side of Ashuganj Fertilizer and Chemical Company Ltd.

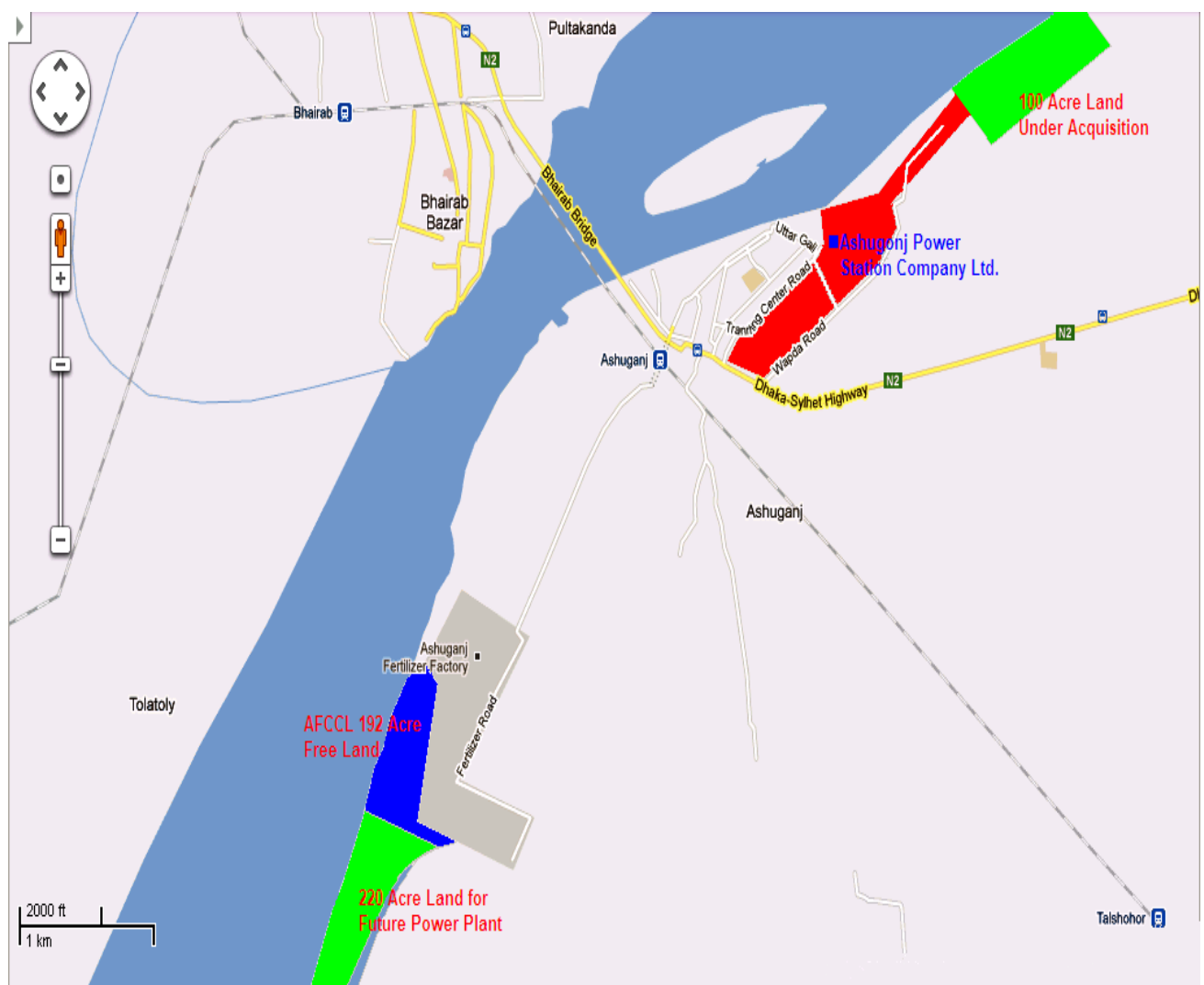

Probable site for future power plant project

Importance of the Meghna River for existing and future power plants:

The existing 9 Units of Ashuganj Power Station Company Ltd. consume a large amount of water every day for generating steam and cooling purpose. The only source of the consumed water is The Meghna River. The Meghna River is very crucial factor of power generation. Most of the future power plant projects are Combined Cycle Power Plant (CCPP). The ST unit of CCPP requires adequate supply of water. Institute of Water Modeling (IWM) completed a Bathymetric Survey work of The Meghna River under the supervision of Atlanta Enterprise Ltd. to find out the capacity of the river. Depth of Meghna River at different places according to the Bathymatric survey report as below:

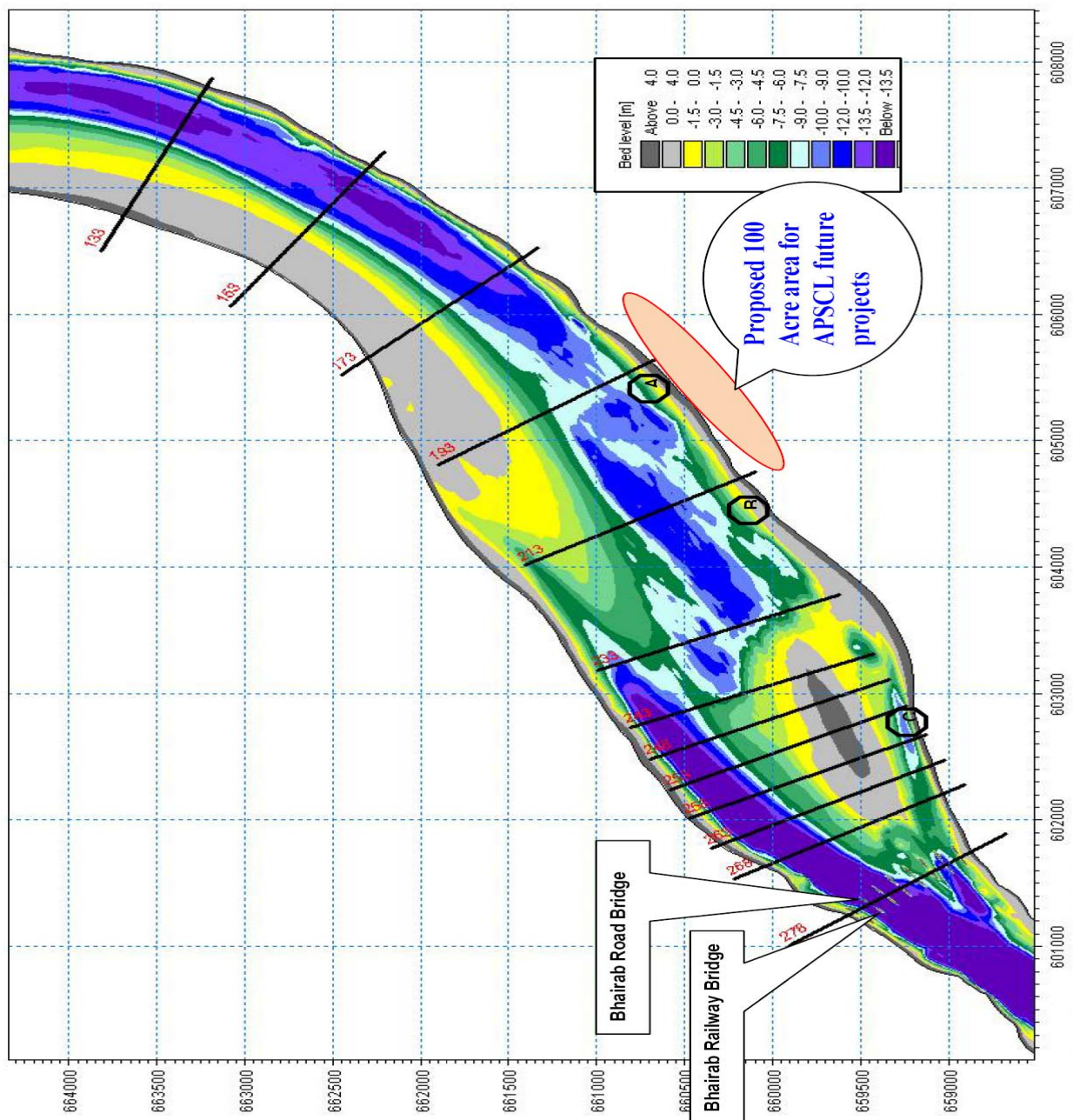

Level of river bed of Meghna River at different places according to the Bathymatric survey report

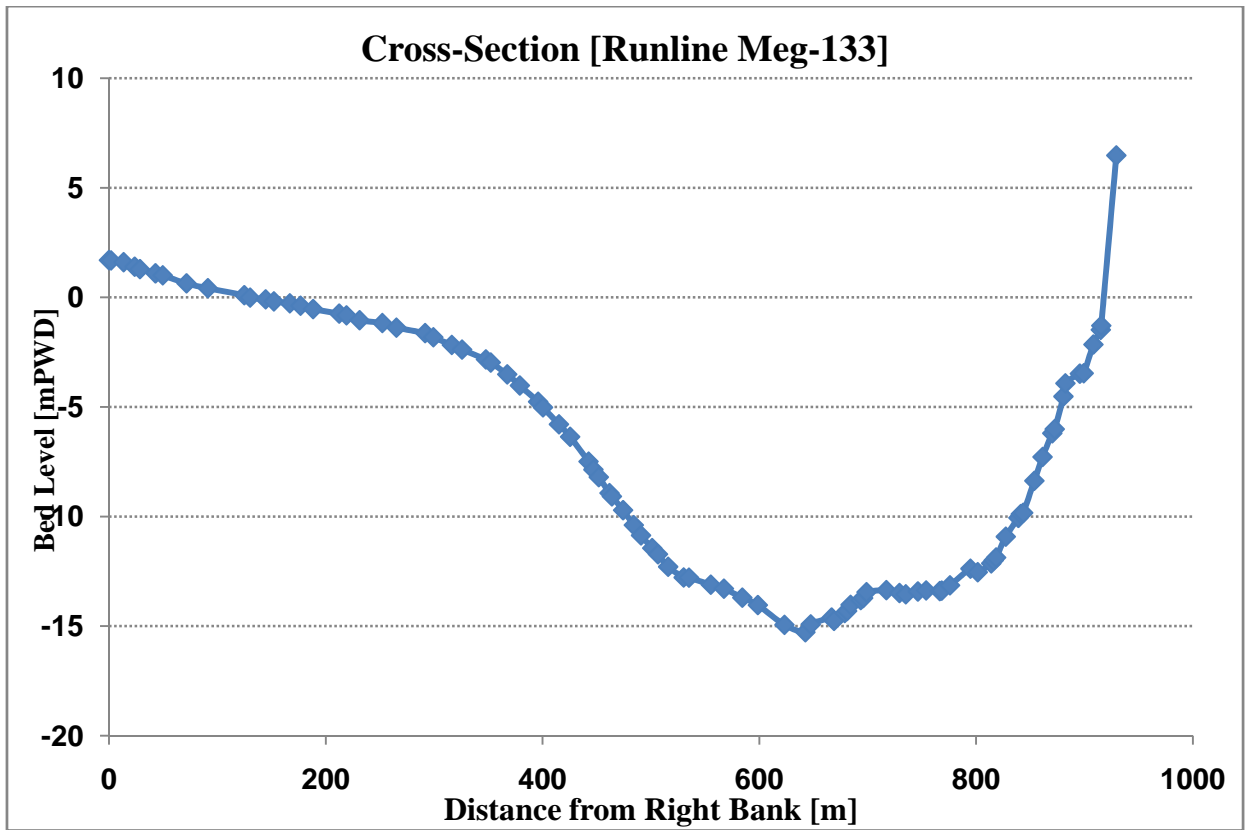

According to the runline Meg-133 cross sectional Depth of river Meghna

Challenges of APSCL for Implementation of Future Projects:

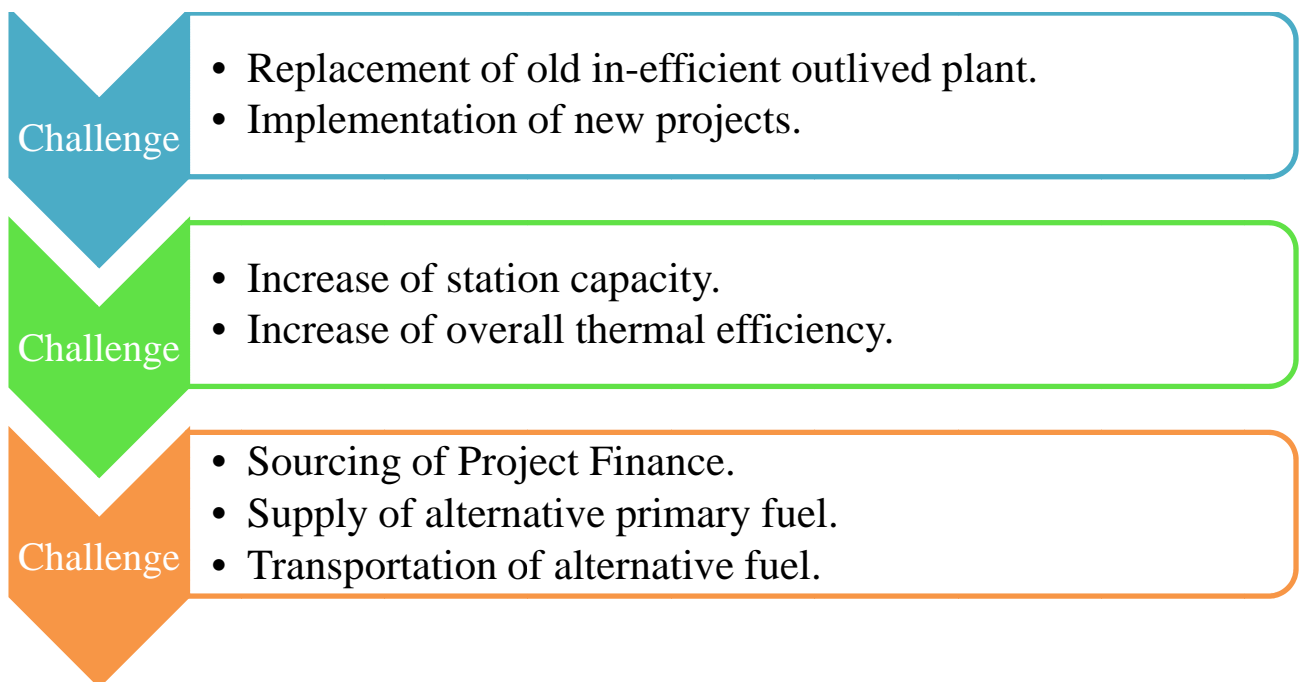

APSCL Strength to Face the Challenges:

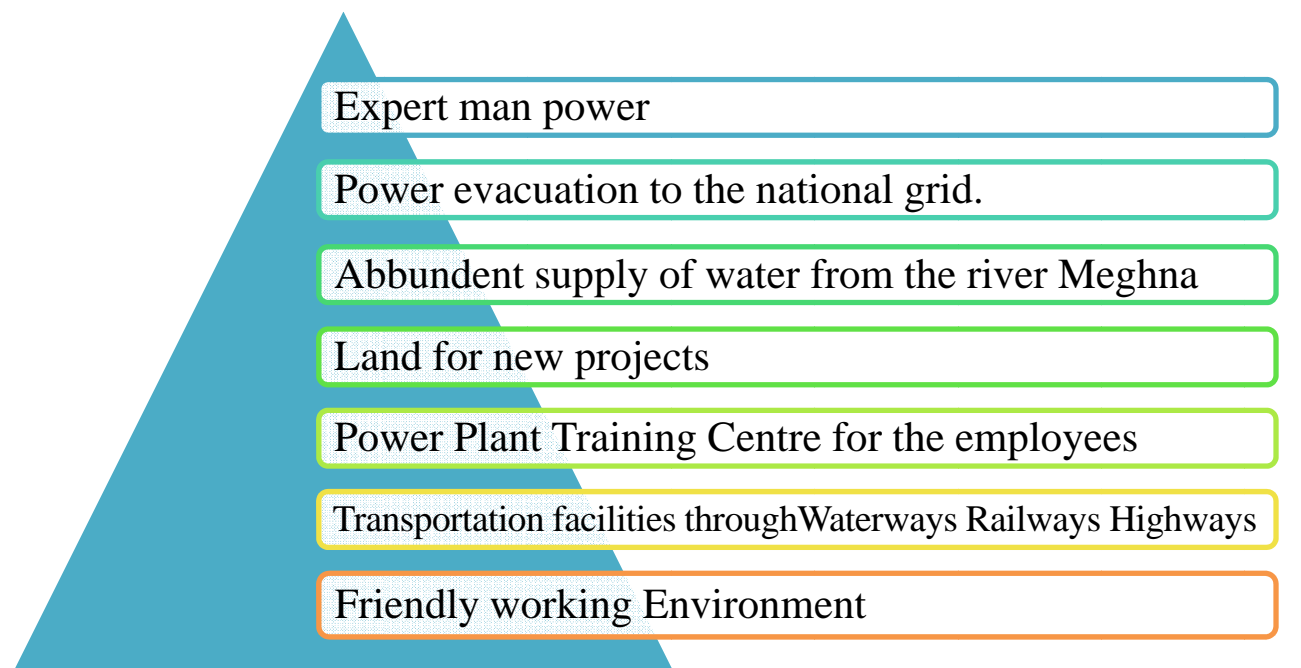

Objective

Enhance the station's dependable capacity in order to cope up with the government's target to provide electricity for all by 2021 and increase overall thermal efficiency of the station by installing high efficient new plant



ASHUGANJ POWER STATION COMPANY LTD.

Ashuganj, B.Barua-3402, Bangladesh

Phone: +88-08528-74004, Fax: +88-08528-74014, 74044

E-mail : apscl@apscl.com, apsclbd@yahoo.com, Website : www.apscl.com
